

Ersatzteil Sonde + Adapter

Für alle Staufix Premium Systeme und Ecolift für folgende Schaltgeräte:

80073, 28073, 80071, 28071, 21071 und Ersatz Sonden 80085, 80086, 80087, 80088, 680117, 680455

Beachten Sie die Sicherheitshinweise und weitere Beschreibung in den zugehörigen EBAs.

Gültig ab Baujahr 01/2011

Lieferumfang

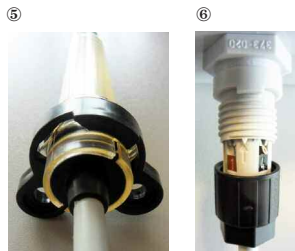
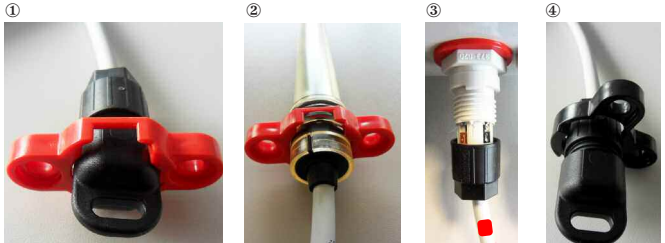

- Für den Ersatz der Pumpensonde ist der rote Adapter (**der Rote Adapter entspricht der alten Sonde 80086!**) richtig aufzustecken (Bajonettverschluss, 1/4 Umdrehung gegen den Uhrzeigersinn) und den roten Aufkleber am Sondenkabel in Steckernähe anbringen – siehe Bild 1-3.

- Für den Ersatz der Motorsonde ist der schwarze Adapter richtig aufzustecken – siehe Bild 4-6.

Montagehinweis Adapter:

Wenn bauseits erforderlich (z. B. Kabelleerrohr, Länge ändern, etc.)

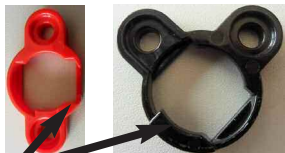

- Diese Erhöhungen verhindern einen Fehlverbau und müssen beim Verschrauben am Rückstausystem nach oben zeigen.



Schwarze Verschraubung abschrauben



Stecker abziehen Rückstände entfernen

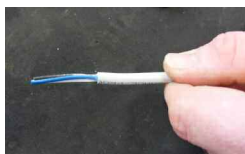
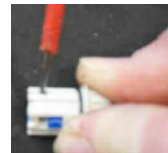

Alte Kontaktstellen entfernen und neu abisolieren



Kabel bis Anschlag einführen

➔ Drehmoment siehe Seite 19

Fortsetzung Seite 2 ➔

Wenn bauseits erforderlich (z. B. für Kabelleerrohr, Länge ändern)

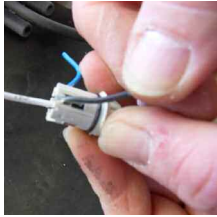

Adern gemäß Belegung einklemmen



Überstehendes Kabel bündig abschneiden



Schwarze Verschraubung aufschrauben



Pfeil zu Nase

Belegung der Adern am Stecker:
 Blauer Draht auf blaue Markierung, weißer Draht auf weiße Markierung, schwarzer Draht auf schwarze Markierung.

Zubehör:
 Verlängerungset für Sonde (10 m)
 Art. Nr. 80889

Gültig von Baujahr 1996-2010

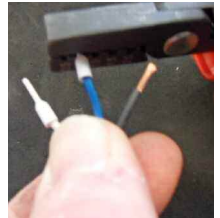
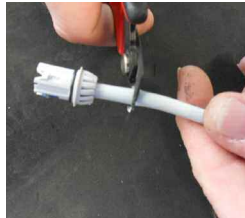

rote und grüne Platine



Gültig bis Baujahr 1996

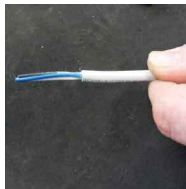
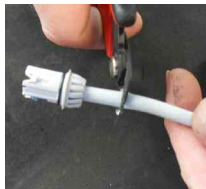

ACHTUNG: Anschluss Sonde nur bei Schaltgeräten bis Bj. 1996

Kabel	Steckerposition
Blau	1
Weiß	2
Schwarz	3

Verwendung der einzelnen Adapter abhängig vom Sondentyp bzw. vom Rückstausystem (siehe 1-3)

Allgemein: Die Adapter dienen zur Befestigung der neuen Sonden ohne Befestigungslaschen.

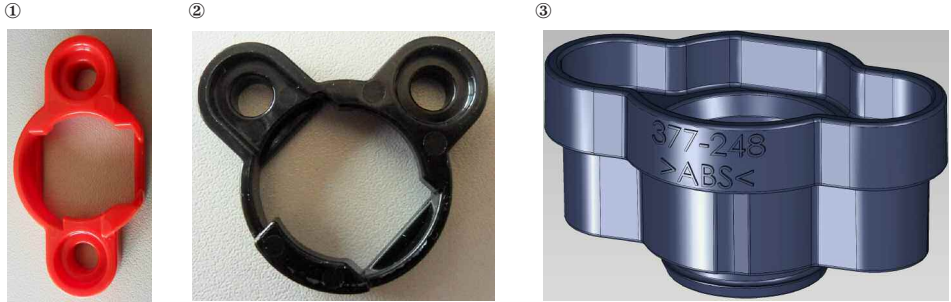

- ① Gültig ab 01/2011
Adapter für alle Pumpensonden
Gültig bis 12/2010
Adapter für alle Sonden Staufix FKA und Pumpfix F mit Nennweite DN 100
- ② Gültig ab 01/2011
Adapter für alle Motorsonden
- ③ Gültig bis 12/2010
Adapter für alle Sonden Staufix FKA und Pumpfix F mit Nennweite DN 125 und DN 150

Montagehinweis Adapter:

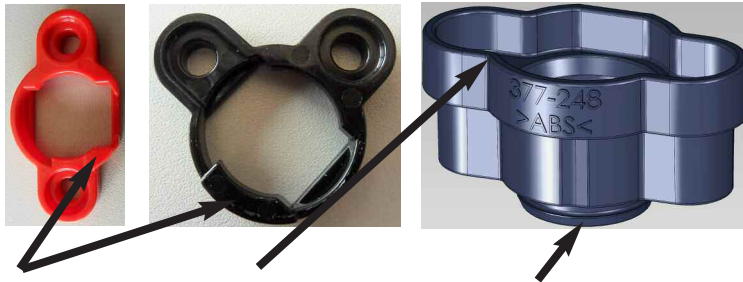

- Diese Erhöhungen verhindern einen Fehlverbau und müssen beim Verschrauben am Rückstausystem nach oben zeigen.
- Hier ist auf ordentlichen Sitz des O-Ringes zu achten.

INSTALLATION INSTRUCTION

Replacement Probe + Adaptor

For all Staufix Premium and Ecolift backwater valves / pumps for the following control units 80073, 28073, 80071, 28071, 21071 and replacement probe 80085, 80086, 80087, 80088, 680117, 680455

Please follow the safety and product information contained in the Install. and User's manual

Valid beginning Jan 2011
Contents of delivery



- When replacing the pump probe the red plastic adaptor must be properly connected (attached and turn a quarter turn clockwise). Also take the small red sticker and stick it to the probe cable near the connection plug (see photos 1-3).
- When replacing the motor probe the black plastic adaptor must be connected (see photos 4-6)

Adaptor installation instructions: If required on-site (ex. for conduit pipes, cable length changes, etc.)

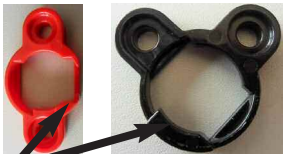

- These raised tips prevent the probe from being connected improperly and must always point upward.



Unscrew the black connector.



Remove plug.

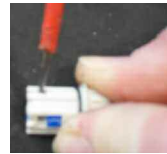

Remove any residue.



Restrip cables.



Insert cables until they contact back of plug.

→ Torque see page 19

Continued page 5 →

If required on-site (for example for conduit pipes, cable length changes, etc.)

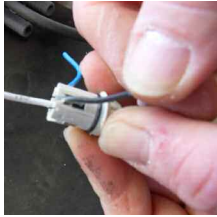

Connect cables to proper position (see description to the right)



Cut off any cable portions which are sticking out



Re-screw the black connector to the plug



Arrow on plug should match triangular tip on threads.

Cable description:

Blue cable on blue mark, white cable on white mark, black cable on black mark

Accessories:

10 meter probe cable extension - Article Number 80889

Valid from 1996 to 2010

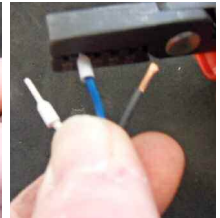
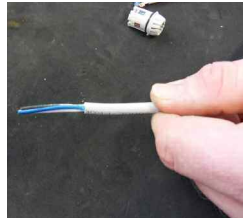

Red and green circuit board



Valid up to 1996

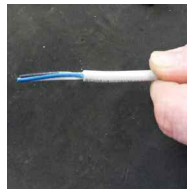
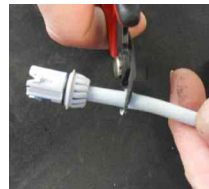

Attention: connection of probe on for control units up to 1996

Cable	Jack
blue	1
white	2
black	3

Continued page 6 →

Use each adaptor depending on probe type and the backwater system (see 1-3)

General: The adaptors are used to fasten the new Probes without mounting brackets.

①



②



③



① For models January 2011 and newer
Adaptor for all pump optical sensors
For models up to December 2010
Adaptor for all Staufix FKA and Pumpfix F
optical sensors for DN 100 (OD 110 mm) models

② For models January 2011 and newer
Adaptor for all motor optical sensors

③ For models up to December 2010
Adaptor for all Staufix FKA and Pumpfix F
optical sensors for DN 125 (OD 125 mm) and DN 150 (OD
160 mm) models.

Must be used in combination with the red adaptor
(adaptor ① is inserted into the top of adaptor ③).

Installation note adaptor:

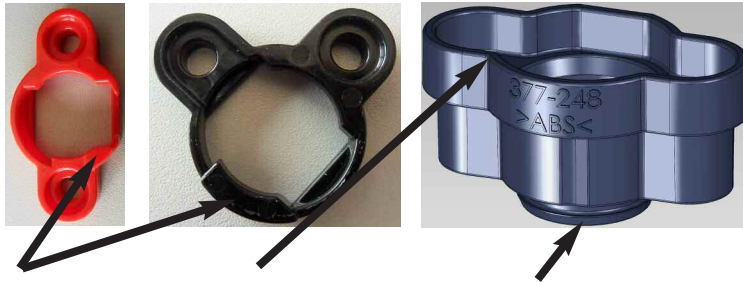

- The raised edge on the adaptors are to assure the adaptor is installed properly and should always be pointing up.

AVIS DE MONTAGE

Pièce de rechange sonde + adaptateur

Approprié à tous les systèmes Staufix Premium et Ecolift pour les boîtiers de commande suivants : 80073, 28073, 80071, 28071, 21071 et les sondes de rechange 80085, 80086, 80087, 80088, 680117, 680455

Observez les consignes de sécurité et autres descriptions données dans les instructions de montage respectives.

Valable à partir de l'année de construction 01/2011

Fournitures



- Emboîtez l'adaptateur rouge (l'adaptateur rouge correspond à l'ancienne sonde 80086 !) correctement (emboîtement à baïonnette, 1/4 de tour contre le sens des aiguilles d'une montre) et fixez l'autocolleant rouge sur le câble de la sonde à proximité directe de la fiche si vous devez remplacer la sonde de la pompe – voir figure 1-3
- Emboîtez l'adaptateur noir correctement si vous devez remplacer la sonde du moteur – voir figure 4-6.

Avis de montage de l'adaptateur : Si nécessaire sur site (p. ex. pour conduit de câbles, la modif. de la longueur etc.)

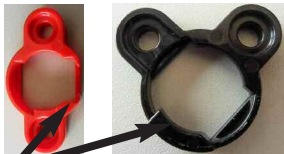

- Ces compensations de hauteur préviennent le risque d'une pose erronée et doivent pointer vers le haut après le vissage sur le système de protection anti-retour.



Dévissez le vissage noir



Retirez la fiche

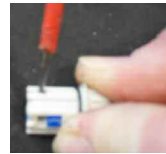

Éliminez les dépôts

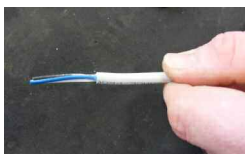

Enlevez les vieux contacts et réisolez



Introduisez le câble jusqu'à la butée

→ Torque voir page 19

Suite à la page 8 →

Si nécessaire sur site (p. ex. pour un conduit de câbles, la modification de la longueur etc.)

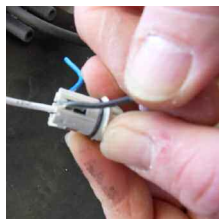

Serrez les conducteurs conformément à l'occupation (voir à droite)



Coupez le câble excédentaire à franc-bord



Vissez le vissage noir



Flèche vers le tenon

Occupation des conducteurs de la fiche :

conducteur bleu sur le repère bleu, conducteur blanc sur le repère blanc, conducteur noir sur le repère noirwarze Markierung.

Accessoire :

kit de rallonge pour sonde (10 mètres)

Réf. n° 80889

Valable à partir de l'année de construction 1996-2010

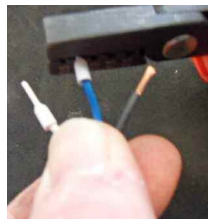
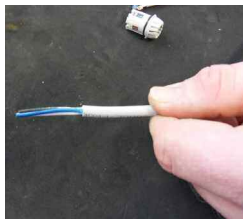
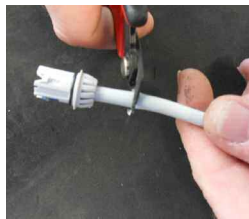

platine rouge et verte



Valable jusqu'à l'année de construction 1996

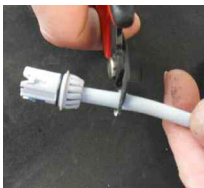

ATTENTION : raccordement de la sonde uniquement pour boîtiers de commande jusqu'à l'année de construction 1996.

Câble	Position sur la fiche
Bleu	1
Blanc	2
Noir	3

Utilisation des différents adaptateurs en fonction du type de sonde et / ou du système de protection anti-retour (voir 1-3)

En général : les adaptateurs servent à la fixation des nouvelles sondes sans languettes de fixation.

①



②



③



- ① Valable à partir de 01/2011
Adaptateur pour toutes les sondes de pompe

Valable jusqu'à 12/2010
Adaptateur pour toutes les sondes Staufix FKA et Pumpfix F d'un diamètre nominal DN 100

- ② Valable à partir de 01/2011
Adaptateur pour toutes les sondes du moteur

- ③ Valable jusqu'à 12/2010
Adaptateur pour toutes les sondes Staufix FKA et Pumpfix F d'un diamètre nominal DN 125 et DN 150

Avis de montage de l'adaptateur :



- Ces compensations de hauteur préviennent le risque d'une pose erronée et doivent pointer vers le haut après le vissage sur le système de protection anti-retour.

- Apportez une importance particulière au logement correct du joint torique.

ISTRUZIONI PER IL MONTAGGIO

Pezzo di ricambio sonda + adattatore

Per tutti i sistemi Staufix Premium ed Ecolift per le seguenti centraline:

80073, 28073, 80071, 28071, 21071 e sonde di ricambio 80085, 80086, 80087, 80088, 680117, 680455

Rispettare le avvertenze sulla sicurezza e l'ulteriore descrizione nelle relative istruzioni per il montaggio. Valido dall'anno di costruzione 01/2011

Volume della fornitura

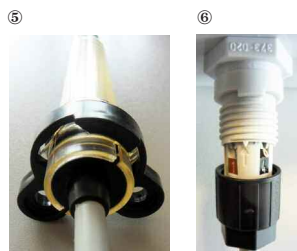
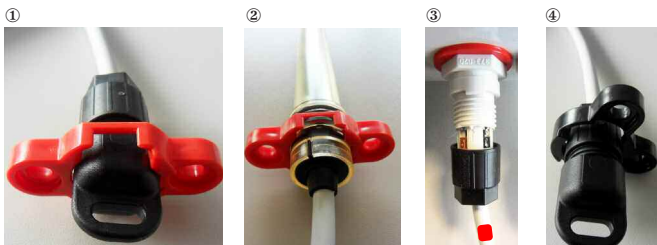

- Per la sostituzione della sonda della pompa applicare correttamente l'adattatore rosso (che corrisponde alla vecchia sonda 80086!) (chiusura a baionetta, ¼ di giro in senso antiorario) e l'adesivo rosso sul cavo della sonda vicino alla spina – vedi illustrazione 1-3
- Per la sostituzione della sonda del motore applicare correttamente l'adattatore nero – vedi illustrazione 4-6

Istruzioni per il montaggio dell'adattatore:

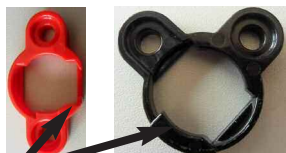

- Questi rialzi impediscono un montaggio errato e durante l'avvitamento sul sistema antiriflusso devono essere rivolti verso l'alto.

Se necessario a cura del committente (p.es. per tubo vuoto per cavi, modificare la lunghezza, ecc.)



Svitare il raccordo a vite nero

Staccare la spina Eliminare i residui



Eliminare i punti di contatto vecchi e rispelare



Introdurre il cavo fino all'arresto

→ Coppia vedere a pagina 19

Continua a pagina 11 →

Se necessario a cura del committente (p.es. per tubo vuoto per cavi, modificare la lunghezza)

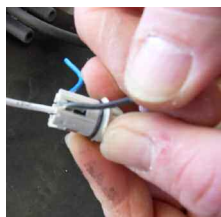

Collegare i fili secondo l'occupazione (vedi destra)



Tagliare a paro il cavo sporgente



Avvitare il raccordo a vite nero



Freccia verso il nasello

Occupazione dei fili sulla spina:

filo blu sul contrassegno blu, filo bianco sul contrassegno bianco, filo nero sul contrassegno nero.

Accessori:

set di prolungamento per sonda (10 m) n. art. 80889

Valido dall'anno di costruzione 1996-2010

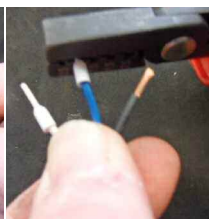
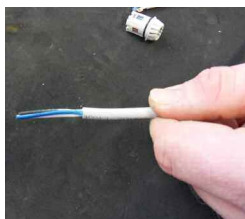

scheda rossa e verde



Valido dall'anno di costruzione 1996

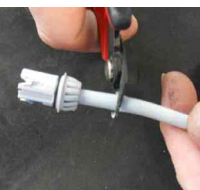

ATTENZIONE : collegamento sonda solo per centraline fino all'anno di costruzione 1996

Cavo	Posizione spina
blu	1
bianco	2
nero	3

Continua a pagina 12 →

Uso dei singoli adattatori secondo tipo di sonda o sistema antiriflusso (vedi 1-3)

In generale: gli adattatori servono al fissaggio senza linguette delle nuove sonde.

①



②



③



① Valido dallo 01/2011

Adattatore per tutte le sonde delle pompe

Valido fino al 12/2012

Adattatore per tutte le sonde Staufix FKA e Pumpfix F
con diametro nominale DN 100

② Valido dallo 01/2011

Adattatore per tutte le sonde dei motori

③ Valido fino al 12/2010

Adattatore per tutte le sonde Staufix FKA e Pumpfix F
Con diametro nominale DN 125 e DN 150

Istruzioni per il montaggio dell'adattatore:



- Questi rialzi impediscono un montaggio errato e durante l'avvitamento sul sistema antiriflusso devono essere rivolti verso l'alto.

- Qui si deve assicurare un posizionamento corretto della guarnizione OR.

MONTAGE-INSTRUCTIE

Onderdeel sonde en adapter

Voor alle Staufix Premium systemen en Ecolift voor de volgende schakelapparaten: 80073, 28073, 80071, 28071, 21071 en reservesonden 80085, 80086, 80087, 800888, 680117, 680455

Neem de veiligheidsinstructies en overige omschrijvingen in de bijbehorende EBAs in acht.

Geldig vanaf bouwjaar 01/2011

Leveringsprogramma



- Om de pompsonde te vervangen moet de rode adapter (de rode adapter komt overeen met de oude sonde 80086!) correct worden ingestoken (bajonetsluiting, 1/4 omdraaiing tegen de wijzers van de klok in) en moet de rode sticker op de sondekabel in de buurt van de stekker worden aangebracht – zie afbeelding 1-3.
- Om de motorsonde te vervangen moet de zwarte adapter correct worden ingestoken – zie afbeelding 4-6.

Montage-instructie adapter:

Wanneer op locatie noodzakelijk (bv. voor lege kabelbuis, lengte veranderen, enz.)

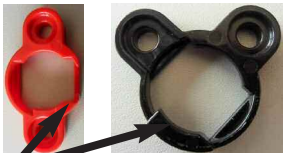

- Deze verhogingen voorkomen foutieve installatie en moeten bij het vastschroeven aan het opstuwingssysteem aan de bovenkant zitten.



Zwarte schroefkoppeling afschroeven



Stekker uittrekken Residuen verwijderen

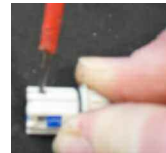

Oude contactpunten verwijderen en opnieuw isoleren



Kabel tot aanslag inbrengen

→ Torque zie pagina 19

Voortzetting pagina 14 →

Wanneer op locatie noodzakelijk (bv. voor lege kabelbuis, lengte veranderen)

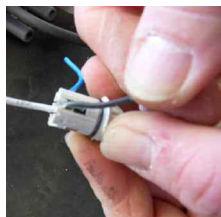

Leidingdraden conform indeling (zie rechts) inklemmen



Uitstekende kabel gelijk afsnijden



Zwarte schroefkoppeling opschroeven



Pijl naar uitstulping

Indeling van de leidingdraden bij de stekker:

blauwe draad op blauwe markering, witte draad op witte markering, zwarte draad op zwarte markering.

Accessoires:

Verlengset voor sonde (10 m)
Art.nr. 80889

Geldig vanaf bouwjaar 1996-2010

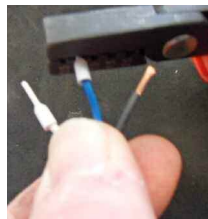
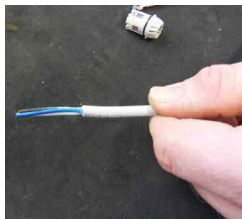

Rode en groene printplaat



Geldig tot bouwjaar 1996

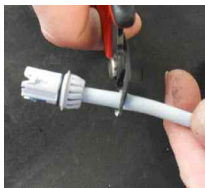

ATTENTIE: Aansluiting sonde uitsluitend bij schakelapparaten tot bouwjaar 1996

Kabel	Stekkerpositie
Blauw	1
Wit	2
Zwart	3

Voortzetting pagina 15 →

Gebruik van de afzonderlijke adapters afhankelijk van het sondetype resp. van het opstuwingsysteem (zie 1-3)

Algemeen: De adapters dienen ter bevestiging van de nieuwe sonden zonder bevestigingsstrips.

①



②



③



① Geldig vanaf 01/2011

Adapter voor alle pompsonden

Geldig tot 12/2010

Adapter voor alle sonden Staufix FKA en Pumpfix F met nominale doorlaat DN 100

② Geldig vanaf 01/2011

Adapter voor alle motorsonden

③ Geldig tot 12/2010

Adapter voor alle sonden Staufix FKA en Pumpfix F met nominale doorlaat DN 125 en DN 150

Montage adapter:



- Deze verhogingen voorkomen foutieve installatie en moeten bij het vastschroeven aan het opstuwingsysteem aan de bovenkant zitten.

- Hier moet op goed zitten van de O-ring worden gelet

WSKAZÓWKA MONTAŻOWA

Część zamienna – Sonda + adapter

Do wszystkich systemów Staufix Premium oraz Ecolift dla następujących sterowników: 80073, 28073, 80071, 28071, 21071 i zamiennych sond 80085, 80086, 80087, 80088, 680117, 680455

Przestrzegać wskazówek bezpieczeństwa oraz dalszych opisów w odpowiednich dokumentach Instrukcja instalacji.

Obowiązuje do roku produkcji 01/2011

Zakres dostawy



- W celu wymiany sondy pompy należy prawidłowo zatknąć czerwony adapter (czerwony adapter odpowiada starej sondzie 80086!) (zamek bagnetowy, 1/4 obrotu przeciwnie do ruchu wskazówek zegara) i następnie czerwoną naklejkę znajdującą się na kablu sondy umieścić w pobliżu wtyczki – patrz rysunek 1-3
- W celu zastosowania sondy silnikowej należy prawidłowo zatknąć czarny adapter – patrz rysunek 4-6

Wskazówka montażowa dla adaptera:

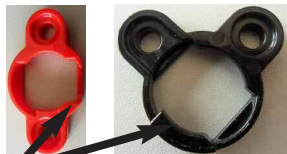

- Te przewyższenia zapobiegają błędnemu montażowi i w przypadku dokręcania do systemu przeciwofkowego muszą wskazywać kierunek do góry.

Jeśli jest to konieczne w miejscu montażu (np. dla rury kablowej, zmiany długości itp.)

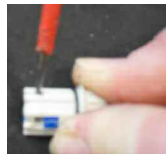

Odkręcić czarne połączenia śrubowe

Odłączyć wtyczki

Usunąć pozostałości



Usunąć wszystkie styki i zaizolować je od nowa



Kabel wprowadzić aż do ogranicznika

➔ Moment obrotowy patrz strona 19

Kontynuacja – strona 17 ➔

Jeśli jest to konieczne w miejscu montażu (np. dla rury kablowej, zmiany długości)

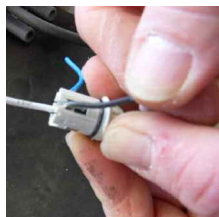

Żyły wpiąć zgodnie z ich obłożeniem (patrz po prawej stronie)

Wystający kabel równo odciąć

Nakręcić czarne połączenie śrubowe

Strzałka do noska

Obłożenie żył na wtyczce:

niebieski przewód na niebieskie zaznaczenie, biały przewód na białe zaznaczenie, czarny przewód na czarne zaznaczenie.

Akcesoria:

zestaw przedłużania dla sondy (10 m) Nr art. 80889

Obowiązuje od roku produkcji 1996-2010

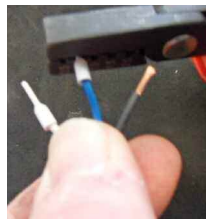
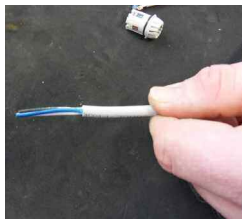

czerwona i zielona płytka



Obowiązuje do roku produkcji 1996

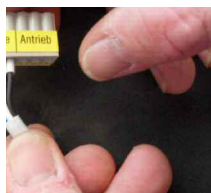
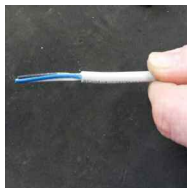
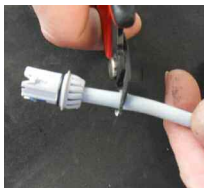

UWAGA! Przyłączenie sondy tylko w sterownikach do roku produkcji 1996

Kabel	Pozycja wtyczki
Niebieski	1
Biały	2
Czarny	3

Kontynuacja – strona 18 →

Zastosowanie poszczególnych adapterów uzależnione od typu sondy lub systemu przeciwcofkowego (patrz 1- 3)

Informacje ogólne: adaptery służą do mocowania nowych sond bez uchwytów mocujących.

①



②



③



- ① Obowiązuje od 01/2011
Adapter do wszystkich sond do pomp
Obowiązuje do 12/2010
Adapter do wszystkich sond Staufix FKA i Pumpfix F o szerokości znamionowej DN 100
- ② Obowiązuje od 01/2011
Adapter do wszystkich sond silnikowych
- ③ Obowiązuje do 12/2010
Adapter do wszystkich sond Staufix FKA i Pumpfix F o szerokości znamionowej DN 125 i DN 150

Wskazówka montażowa dla adaptera:



- Te przewyższenia zapobiegają błędnemu montażowi i w przypadku dokręcania do systemu przeciwcofkowego muszą wskazywać kierunek do góry.

- Należy tu uważać na prawidłowe zamocowanie pierścienia.

D: Drehmoment
GB: Torque
F: Torque
I: Coppia
NL: Torque
PL: Moment obrotowy

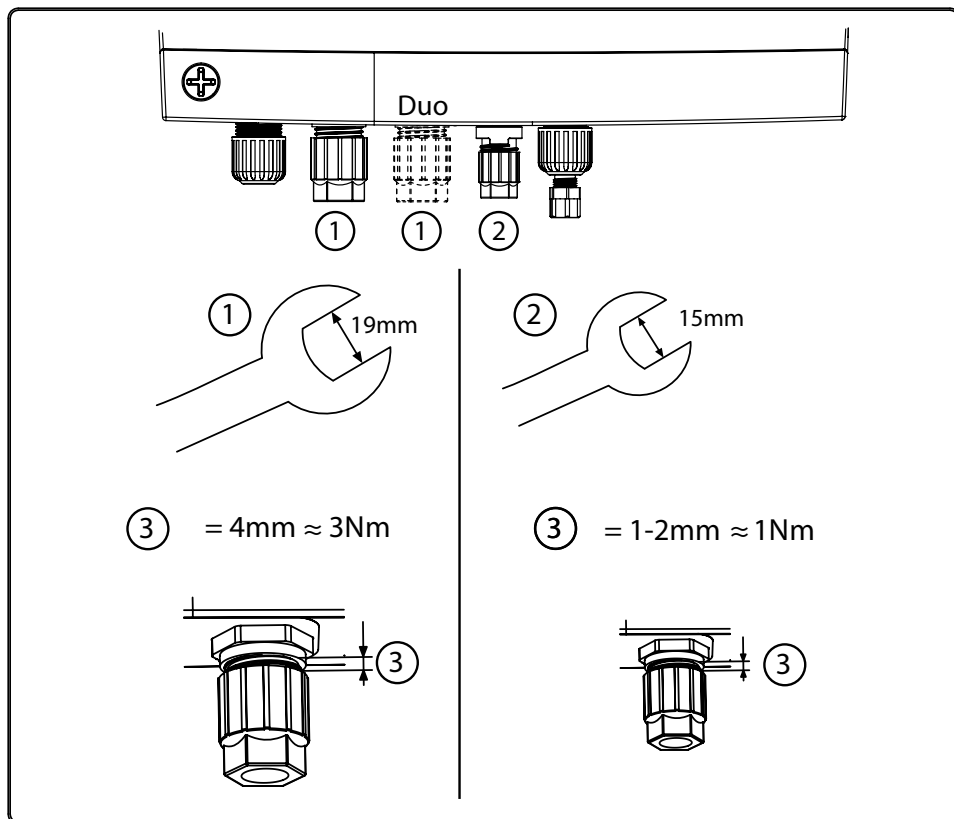

Führend in Entwässerung

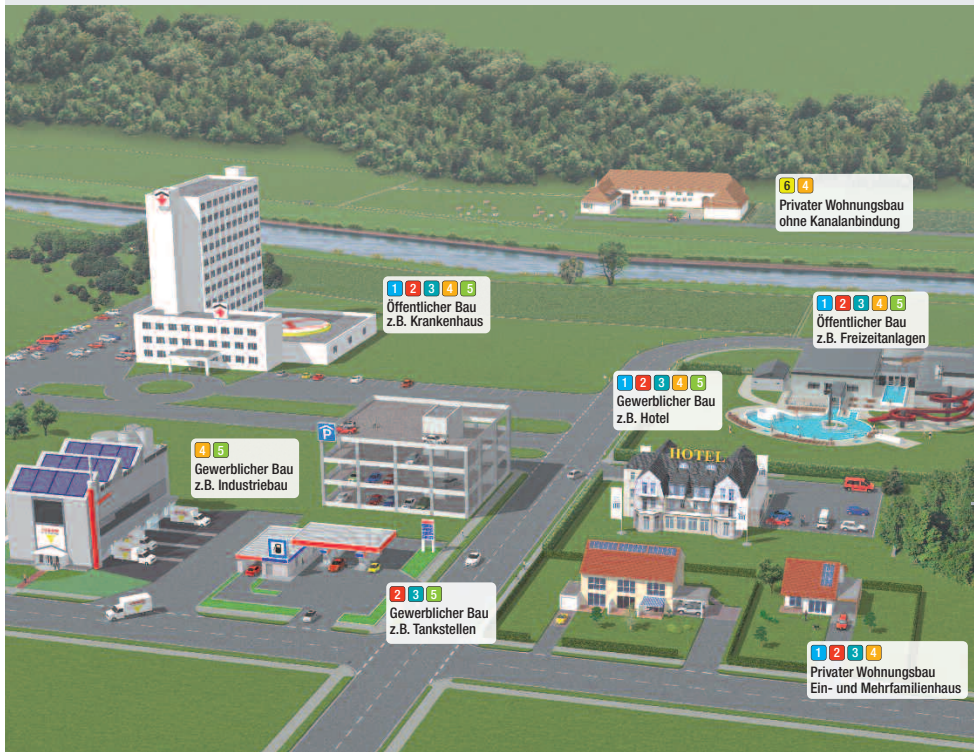

1 Rückstauverschlüsse

2 Rückstauhebeanlagen

3 Hebeanlagen

4 Abläufe / Rinnen

5 Abscheider

6 Kleinkläranlagen

 **KESSEL**