

Lifting station Aqualift F Duo Comfort, SPF 3000-S1, shut-off valve

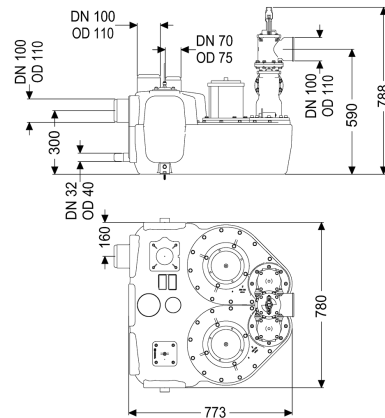

Article information

Item no.: 11609
 GTIN: 4026092071076
 Price group: 20

Advantages

- Different performance classes available
- Pressure sensor for reliable pneumatic level measurement
- Control unit with self-diagnosis system

Description

The lifting station for faecal and faecal-free wastewater is equipped with two submersible pumps and a backflow preventer. The collection tank made of permanently resistant polymer (PE) offers universal connection options and has a screwed access cover.

Variant

Type of system:	duo pump
Shut-off valve:	Shut-off valve made of polymer
Retaining bracket for the lift protection:	yes
Sound absorption mat:	yes
Pump control:	Control unit
Backflow preventer:	integrated
Pressure pipe connection:	horizontal
General characteristics	
Colour:	black
Standard:	EN 12050-1
Type of wastewater:	with sewage
Installation situation:	free-standing installation
Delivery state:	Installation-ready (electrical components, connection parts must be connected on site)

Dimensions

Net weight: 58,83 kg

Gross weight:	84 kg
Length:	773 mm
Width:	780 mm
Height:	788 mm
Packaging dimension:	length
Packaging dimension:	width
Packaging dimension:	height
Tank/drain body	
Pressure pipe connection (DN):	100
Pressure pipe connection (OD):	110 mm
Connection for manual diaphragm pump (DN):	32
Venting connection (DN):	70
Distance from centre of outlet pipe to tank bottom:	590 mm
Distance pipe bottom inlet to tank bottom:	245 mm
Distance from centre of inlet pipe to tank bottom:	300 mm
Inlet max. scoring (DN):	150 mm
Inlet nominal size (OD):	110 mm
Inlet nominal size (DN):	100 mm
Number of inlets:	2
Pumping volume:	50 l
Tank volume:	120 l
Pumping device	
Pump:	SPF 3000-S1
Number of pumps:	2
Weight, pump:	26 kg
Connection type:	Direct connection
Rated current:	5,4 A
Protection class:	I
Insulation class:	F
Cos phi - power factor:	0,77
Protection class (pump):	IP 68 (3m/48h)
Temperature monitoring:	integrated
Max. temperature (permanent) of conveyed material:	40 °C
Max. pumping capacity:	47 m ³ /h
Max. pumping height:	16 m
Speed:	2890 U/min
Power P1:	3,2 kW
Power P2:	2,7 kW
Operating mode:	S1
Type of pump connection cable:	H07RN-F 7G 1.5 mm ²
Impeller type:	Multi-vane impeller
Free passage:	40 mm
Length of mains cable for pump:	5 m

Control

Control unit:	Comfort
Motor protection switch:	yes
Alarm sensor:	Immersion pipe
Level measurement instrument:	Immersion pipe with pressure monitor
Type of level measurement:	pneumatic
Protection class control unit:	IP 54
Mains frequency:	50 Hz
Operating voltage:	400 V
Connection type:	Direct connection
Potential-free contact:	yes
GSM interface:	yes
Log book function:	yes
Multi-line display:	yes
Battery buffering:	yes
Self-diagnosis system (SDS):	yes