

## Shower chan. Linearis Infinity 60 L: 1400 mm, DN40, Polished SST, Megastop

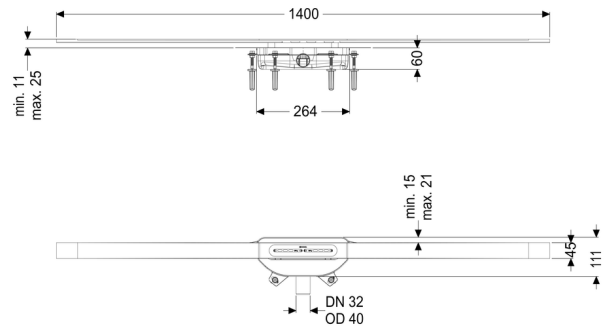

### Article information

Item no.: 45301.14  
 GTIN: 4026092094167  
 Price group: 10

### Description

The narrow Linearis Infinity channel for walk-in showers is suitable for indoor linear drainage for household and commercial use. The channel profile made of 316 stainless steel can be extended straight or at three (30, 45 and 90 degree) angles.

The drain body made of PP is equipped with sound and settlement absorbers. The channel contains a clip-on flange with factory-mounted waterproofing membrane to EN 1253-1 and DIN 18534-1-W3-I. The channel profile can be pushed in the lengthwise and transverse direction in the clip-on flange to level out construction tolerance.

Including Megastop mechanical odour trap with water seal.

Open seepage water openings, without flooding of the waterproofing level in the event of backwater.

### Version:

Odour trap:	Megastop (mechanical)
Type of waterproofing layer:	Factory-fitted sealing collar (WaD) according to DIN 18534
Water exposure class in accordance to DIN 18534-1 (up to and including):	W3-I

**General characteristics:**

Nominal size (DN): 40

**Dimensions:**

Length: 264 mm  
Width: 111 mm  
Min. design height: 60 mm

**Tank:**

Outlet nominal size (DN): 40  
Outlet nominal size (OD): 40

**Drain body:**

Material of drain body: PP  
Socket version: lateral

**Coverage features:**

Type of cover: Stainless steel cover  
Cover material: 316 stainless steel  
Min. flooring height: 11 mm  
Max. flooring height: 25 mm  
Load class: K 3 (EN 1253-1)  
Length: 1,400 mm  
Width: 45 mm  
Surface: Polished SST  
Locking: placed

Shape of upper section: square  
Discharge rate (l/s) with 10 mm backwater: 0.2 l/s  
Discharge rate (l/s) with 20 mm backwater: 0.4 l/s