

Shower chan. Linearis Infinity 60 L: 1000 mm, DN 40, Black, br., Megastop

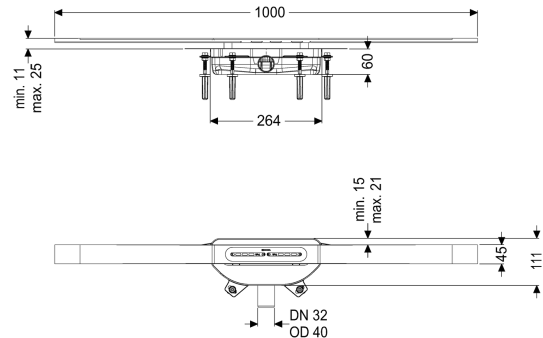

Article information

Item no.: 45302.10
 GTIN: 4026092094303
 Price group: 10

Advantages

- Channel profile made of 316 stainless steel
- Including Sound and settlement absorbers
- No flooding of the waterproofing level in the event of water build-up

Description

The narrow Linearis Infinity channel for walk-in showers is suitable for indoor linear drainage for household and commercial use. The narrow Linearis Infinity channel for walk-in showers is suitable for indoor linear drainage for household and commercial use. The channel profile made of 316 stainless steel can be extended straight or at three (30, 45 and 90 degree) angles. The drain body made of PP is equipped with sound and settlement absorbers. These reduce operating noise and can compensate for subsidence in the floor structure. The channel contains a clip-on flange with a factory-mounted waterproofing membrane according to DIN EN 1253-1 and DIN 18534-1-W3-I. The channel profile can be pushed in the lengthwise and transverse direction in the clip-on flange to compensate for construction tolerances. Including Megastop mechanical odour trap with water seal. Open seepage water openings, without flooding of the waterproofing level in the event of build-up.

Variant

Water exposure class in accordance to DIN 18534-1 (up to and including):	W3-I
Discharge rate (l/s) with 10 mm threshold:	0,2
Discharge rate (l/s) with 20 mm threshold:	0,4

General characteristics

Nominal size (DN):	40
--------------------	----

Odour trap:	Megastop
Dimensions	
Net weight:	3,03 kg
Gross weight:	3,03 kg
Min. design height:	60 mm
Vertically adjustable:	yes
Length:	264 mm
Width:	111 mm
Packaging dimension:	length
Packaging dimension:	width
Packaging dimension:	height
Tank/drain body	
Outlet nominal size (OD):	40 mm
Outlet nominal size (DN):	40 mm
Material of drain body:	PP
Socket version:	lateral
Coverage features	
Type of cover:	Stainless steel cover
Cover material:	316 stainless steel
Width of cover:	45 mm
Length of cover:	1000 mm
Min. flooring height:	11 mm
Surface:	Black brushed
Locking:	placed
Load class:	K 3 (EN 1253-1)
Max. flooring height:	25 mm
Shape of upper section:	square